

**HOLLOW PUNCH 45 MM**

**14,46 € excl. tax**  
**17,35 € incl. tax**

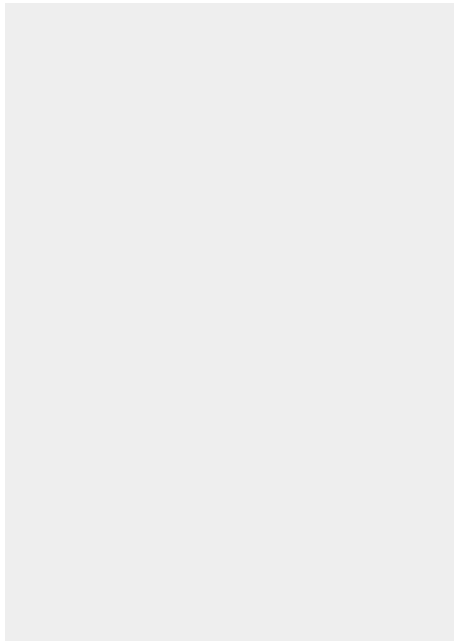

**Made in France**

**SKU:** JLB45 | **Categories:** [Hollow punches Ø41 to 50](#) |

**DESCRIPTION DU PRODUIT**

Made of high resistance steel, Boehm's JLB model hollow punches ensure a precise cut-out of pallets, washers or gaskets in soft materials: paper tape, foam, cardboard, leather, felt, cork, rubber, plastic, fabric, ...etc.

**Compatibility**

This hollow punch can be locked thanks to a spur system on the following chucks and handles : JLBM50, JLBM50PA, JLBM60, JLBM60PA and JLBM100

[See all our striking tools](#)

**Other features:**

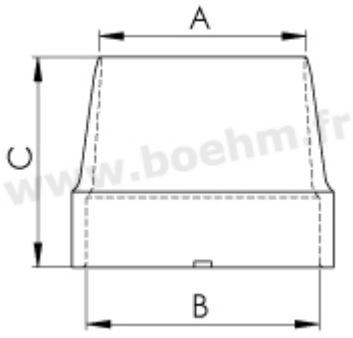

A:45 mm B:52 mm C:42 mm

**Fastening method:** by locking onto chuck or handle (JLB model)

**Twinning possibilities:** [see the twinning table](#)

For more information on how to use these tools, please consult our [our tutorials](#)



**Made in France**

## INFORMATIONS COMPLÉMENTAIRES

**Weight** 0,1 kg

**Diameter in mm** [45.00 mm](#)

