

HOLLOW PUNCH 50 MM

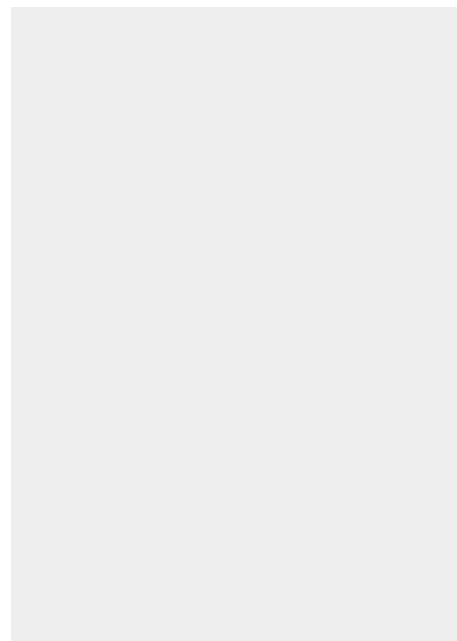

14,46 € excl. tax
17,35 € incl. tax



Made in France

SKU: JLB50 | **Categories:** [Hollow punches Ø41 to 50](#) |

DESCRIPTION DU PRODUIT

Made of high resistance steel, Boehm's JLB model hollow punches ensure a precise cut-out of pallets, washers or gaskets in soft materials: paper tape, foam, cardboard, leather, felt, cork, rubber, plastic, fabric, ...etc.

Compatibility

This hollow punch can be locked thanks to a spur system on the following chucks and handles : JLBM50, JLBM50PA, JLBM60, JLBM60PA and JLBM100

[See all our striking tools](#)

Other features:

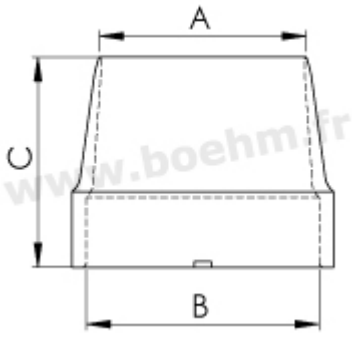

A:50 mm B:52 mm C:42 mm

Fastening method: by locking onto chuck or handle (JLB model)

Twinning possibilities: [see the twinning table](#)

For more information on how to use these tools, please consult our [our tutorials](#)



Made in France

INFORMATIONS COMPLÉMENTAIRES

Weight 0,1 kg

Diameter in mm [50.00 mm](#)

