

HOLLOW PUNCH 60 MM

32,93 € excl. tax
39,52 € incl. tax



Made in France

SKU: JLB60 | **Categories:** [Hollow punches Ø51 to 60](#) |

DESCRIPTION DU PRODUIT

Made of high resistance steel, Boehm's JLB model hollow punches ensure a precise cut-out of pallets, washers or gaskets in soft materials: paper tape, foam, cardboard, leather, felt, cork, rubber, plastic, fabric, ...etc.

Compatibility

This hollow punch can be locked thanks to a spur system on the following chucks and handles : JLBM60, JLBM60PA and JLBM100.

[See all our striking tools](#)

Other features:

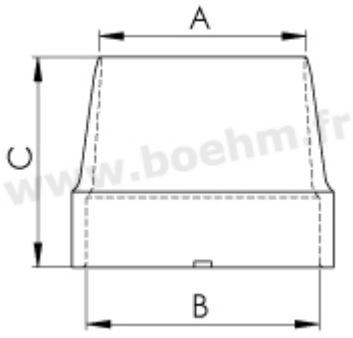

A:60 mm B: 62.5 mm C:47 mm

Fastening method: by locking onto chuck or handle (JLB model)

Twinning possibilities: [see the twinning table](#)

For more information on how to use these tools, please consult our [our tutorials](#)



Made in France

INFORMATIONS COMPLÉMENTAIRES

Weight 0,15 kg

Diameter in mm [60.00 mm](#)

