

HOLLOW PUNCH 92 MM



180,43 € excl. tax
216,52 € incl. tax



Made in France

SKU: JLB92 | **Categories:** [Hollow punches Ø91 to 100](#) |

DESCRIPTION DU PRODUIT

Made of high resistance steel, Boehm's JLB model hollow punches ensure a precise cut-out of pallets, washers or gaskets in soft materials: paper tape, foam, cardboard, leather, felt, cork, rubber, plastic, fabric, ...etc.

Compatibility

This hollow punch can be locked thanks to a spur system on the following chuck: [JLBM100](#).

[See all our striking tools](#)

This hollow punch can be used manually by hitting the material placed on the punch with a mallet around the edge. It can also be installed on a manual press with the chuck [JLBM100](#).

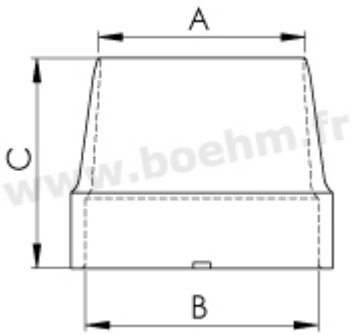
Other features:

A:92 mm B: 104 mm C:67 mm

Fastening method: by locking onto chuck (JLB model)

Twinning possibilities: [see the twinning table](#)

For more information on how to use these tools, please consult our [our tutorials](#)



Made in France

INFORMATIONS COMPLÉMENTAIRES

Weight 0,65 kg

Diameter in mm [92.00 mm](#)

