

## HOLLOW PUNCH 96 MM

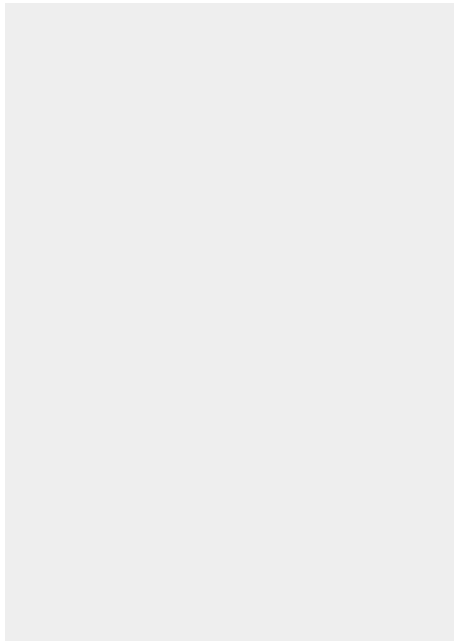

**180,43 € excl. tax**  
**216,52 € incl. tax**



**Made in France**

**SKU:** JLB96 | **Categories:** [Hollow punches Ø91 to 100](#) |

### DESCRIPTION DU PRODUIT

Made of high resistance steel, Boehm's JLB model hollow punches ensure a precise cut-out of pallets, washers or gaskets in soft materials: paper tape, foam, cardboard, leather, felt, cork, rubber, plastic, fabric, ...etc.

### Compatibility

This hollow punch can be locked thanks to a spur system on the following chuck: [JLBM100](#).

[See all our striking tools](#)

This hollow punch can be used manually by hitting the material placed on the punch with a mallet around the edge. It can also be installed on a manual press with the chuck [JLBM100](#).

**Other features:**

A:96 mm B: 104 mm C:67 mm

**Fastening method:** by locking onto chuck (JLB model)

**Twinning possibilities:** [see the twinning table](#)

For more information on how to use these tools, please consult our [our tutorials](#)



**Made in France**

## INFORMATIONS COMPLÉMENTAIRES

**Weight** 0,65 kg

**Diameter in mm** [96.00 mm](#)

