

## HOLLOW PUNCH 31 MM

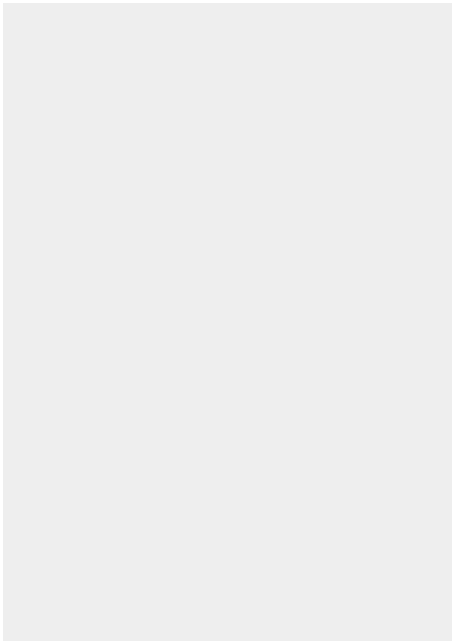

**11,80 € excl. tax**  
**14,16 € incl. tax**



**Made in France**

**SKU:** JLB31 | **Categories:** [Hollow punches Ø31 to 40](#) |

### DESCRIPTION DU PRODUIT

Made of high resistance steel, Boehm's JLB model hollow punches ensure a precise cut-out of pallets, washers or gaskets in soft materials: paper tape, foam, cardboard, leather, felt, cork, rubber, plastic, fabric, ...etc.

### Compatibility

This hollow punch can be locked thanks to a spur system on the following chucks and handles : JLBM50, JLBM50PA, JLBM60, JLBM60PA and JLBM100.

[See all our striking tools](#)

**Other features:**



A:31 mm B:41 mm C:37 mm

**Fastening method:** by locking onto chuck or handle (JLB model)

**Twinning possibilities:** [see the twinning table](#)

For more information on how to use these tools, please consult our [our tutorials](#)



**Made in France**

## INFORMATIONS COMPLÉMENTAIRES

**Weight** 0,07 kg

**Diameter in mm** [31.00 mm](#)

