

## HOLLOW PUNCH16 MM



**6,91 € excl. tax**  
**8,29 € incl. tax**



**Made in France**

**SKU:** JLB16 | **Categories:** [Hollow punches Ø11 to 20](#) |

### DESCRIPTION DU PRODUIT

Made of high resistance steel, Boehm's JLB model hollow punches ensure a precise cut-out of pallets, washers or gaskets in soft materials: paper tape, foam, cardboard, leather, felt, cork, rubber, plastic, fabric, ...etc.

### Compatibility

This hollow punch can be locked thanks to a spur system on the following chucks and handles :

- [JLBM20](#)
- [JLBM30](#)
- [JLBM30PA](#)
- [JLBM50](#)

Fiche article : Hollow punch16 mm - Référence : JLB16

- [JLBM50PA](#)
- [JLBM60](#)
- [JLBM60PA](#)
- [JLBM100](#)

**Other features:**

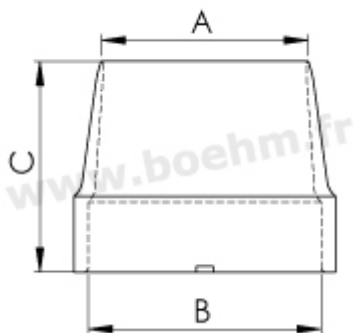

A:16 mm B:21 mm C:27 mm

**Fastening method:** by locking onto chuck or handle (JLB model)

**Twinning possibilities:** [see the twinning table](#)

For more information on how to use these tools, please consult our [our tutorials](#)



**Made in France**

## INFORMATIONS COMPLÉMENTAIRES

**Weight** 0,02 kg

**Diameter in mm** [16.00 mm](#)



