

HOLLOW PUNCH18 MM

6,91 € excl. tax
8,29 € incl. tax

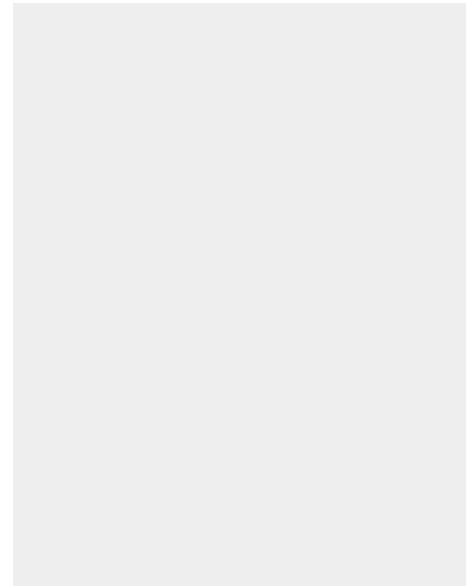
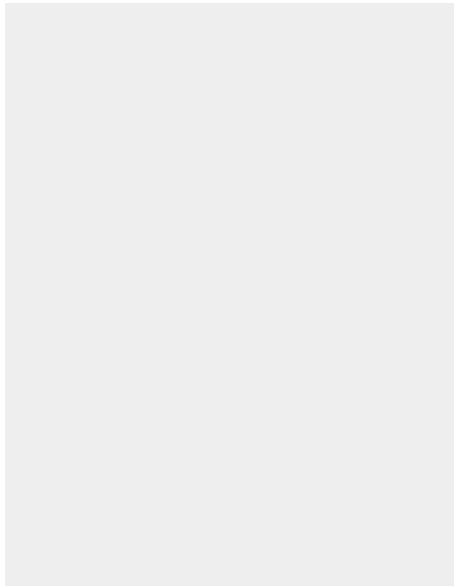

Made in France

SKU: JLB18 | **Categories:** [Hollow punches Ø11 to 20](#) |

DESCRIPTION DU PRODUIT

Made of high resistance steel, Boehm's JLB model hollow punches ensure a precise cut-out of pallets, washers or gaskets in soft materials: paper tape, foam, cardboard, leather, felt, cork, rubber, plastic, fabric, ...etc.

Compatibility

This hollow punch can be locked thanks to a spur system on the following chucks and handles :

- [JLB20](#)
- [JLB30](#)
- [JLB30PA](#)
- [JLB50](#)

Fiche article : Hollow punch18 mm - Référence : JLB18

- [JLBM50PA](#)
- [JLBM60](#)
- [JLBM60PA](#)
- [JLBM100](#)

Other features:

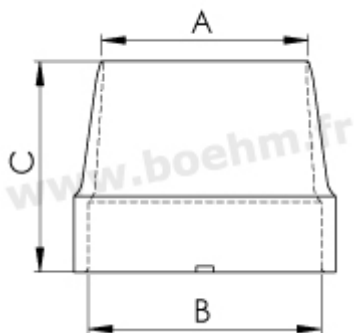

A:18 mm B:21 mm C:27 mm

Fastening method: by locking onto chuck or handle (JLB model)

Twinning possibilities: [see the twinning table](#)

For more information on how to use these tools, please consult our [our tutorials](#)



Made in France

INFORMATIONS COMPLÉMENTAIRES

Weight 0,02 kg

Diameter in mm [18.00 mm](#)

