

HOLLOW PUNCH 33 MM

13,57 € excl. tax
16,28 € incl. tax

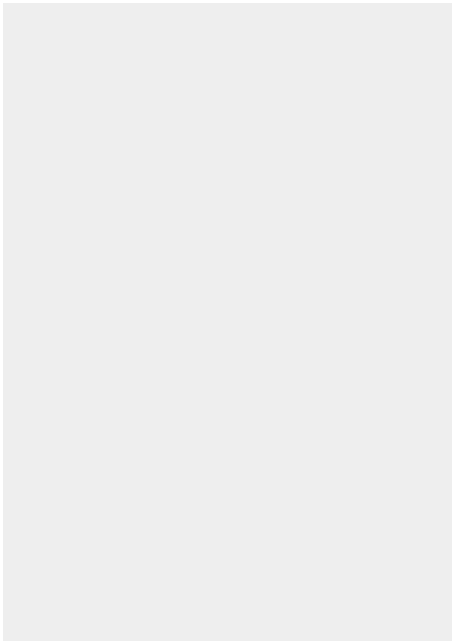

Made in France

SKU: JLB33 | **Categories:** [Hollow punches Ø31 to 40](#) |

DESCRIPTION DU PRODUIT

Made of high resistance steel, Boehm's JLB model hollow punches ensure a precise cut-out of pallets, washers or gaskets in soft materials: paper tape, foam, cardboard, leather, felt, cork, rubber, plastic, fabric, ...etc.

Compatibility

This hollow punch can be locked thanks to a spur system on the following chucks and handles : JLBM50, JLBM50PA, JLBM60, JLBM60PA and JLBM100.

[See all our striking tools](#)

Other features:

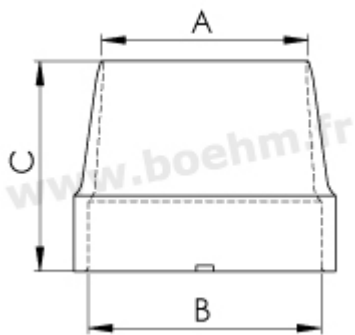

A:33 mm B:41 mm C:37 mm

Fastening method: by locking onto chuck or handle (JLB model)

Twinning possibilities: [see the twinning table](#)

For more information on how to use these tools, please consult our [our tutorials](#)



Made in France

INFORMATIONS COMPLÉMENTAIRES

Weight 0,07 kg

Diameter in mm [33.00 mm](#)

